

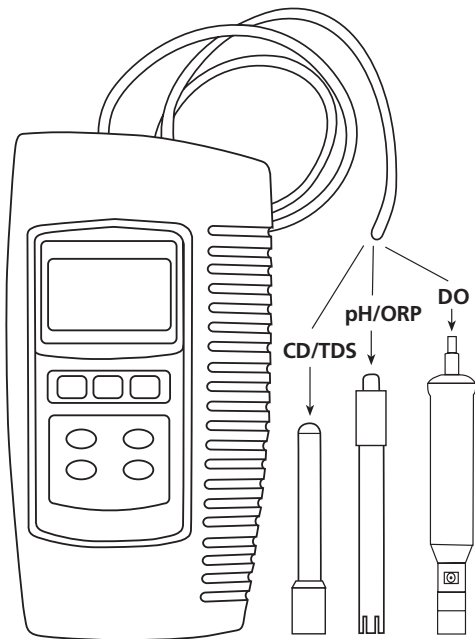

# SensoDirect 150

MultiMeter Instrument - Instruction Manual



## Table of Contents

1.	Specifications .....	1
1.1	General Specifications .....	1
1.2	Electrical Specifications .....	2
2.	Front Panel Description .....	5
3.	pH/mV Measuring and Calibration Procedure .....	7
4.	Conductivity/TDS Measuring and Calibration Procedure .....	13
5.	DO (Dissolved Oxygen) Measuring and Calibration Procedure .....	18
6.	Data Load, Data Record, Data Logger .....	24
7.	Advanced Adjustment Procedure .....	26
7.1	Check Memory Space .....	27
7.2	Clear Memory .....	27
7.3	Date/Time Setting .....	27
7.4	Sample Time Setting .....	27
7.5	Auto Power Off Default Setting .....	28
7.6	Temp. Unit Default Setting .....	28
7.7	pH Manual Temp. Value Setting .....	28
7.8	CD Temp. Compensation Factor Setting .....	28
7.9	CD ( $\mu$ S, mS ), TDS ( ppm ) Setting .....	29
7.10	DO % Salt Compensation Value Setting .....	29
7.11	DO Height (Altitude) Compensation Value Setting .....	30
7.12	Escape from the Setting function .....	30
8.	Data Output .....	31
9.	RS232 PC Serial Interface .....	33
10.	Battery Replacement .....	35
11.	System Reset .....	35
12.	Accessories .....	36

# 1. Specifications

## 1.1 General Specifications

Circuit	Custom microprocessor LSI
Display	LCD size : 58 mm x 34 mm.
Measurement	pH / Oxidation Reduction Potential (ORP) Conductivity/Total Dissolved Solids (TDS) Dissolved Oxygen (DO) Temperature
Sampling Time of Data Logger	1 second to 8 hours 59 minutes and 59 seconds
Data Hold	Freeze the display reading.
Memory Recall	Maximum and Minimum value
Power off	<ul style="list-style-type: none"><li>• Auto shut off saves battery life; manual shut off possible by pressing "Power" button for 2 seconds</li><li>• Default changeable: auto power off/ manual power off</li><li>• With default set at auto power off, power will off automatically after 10 minutes if no button is pressed.</li></ul>
Display lapse time	Approx. 1 second.
Data Output	RS 232 PC serial interface
Operating Temperature	0 to 50 °C (32 to 122°F) for the instrument (not including probes)
Operating Humidity	Less than 80% rel. humidity
Power Supply	<ul style="list-style-type: none"><li>• DC 1.5 V with 4 batteries (mignon size; Type AA)</li><li>• DC 9 V by adapter input</li></ul>
Power Current	<ul style="list-style-type: none"><li>• Operation: approx. DC 28 mA</li><li>• Clock (power off): approx. DC 1 <math>\mu</math>A</li></ul>

Weight	<ul style="list-style-type: none"> <li>• instrument 390 g (batteries included)</li> <li>• with protective covering 620 g</li> </ul>
Dimension	<ul style="list-style-type: none"> <li>• instrument: 203 x 76 x 38 mm</li> <li>• with protective covering: approx. 220 x 125 x 45 mm</li> </ul>

## 1.2 Electrical Specifications (23± 5°C)

### A. pH/mV

Measurement	pH	0 to 14 pH
	mV	-1999 mV to 1999 mV
Input Impedance	10 <sup>12</sup> ohm	
Temperature Compensation for pH measurement	Manual	0 to 100°C (32 to 212°F)
	Automatic (ATC)	0 to 65°C (32 to 149 °F) with temperature probe
pH Calibration	1 to 3 point calibration using pH 7 / pH 4 / pH 10 buffer solutions Three point calibration ensures best linearity and accuracy	

Measurement	Range	Resolution	Accuracy
pH	0 to 14 pH	0.01 pH	± (0.02 pH + 2 digits)
mV	- 1999 to 1999 mV	1 mV	± (0.5 % pH + 2 digits)
* pH accuracy is based on calibrated meter only.			

## B. Conductivity

Conductivity probe	Carbon rod electrode for long life
Function	<ul style="list-style-type: none"> <li>• Conduction (<math>\mu\text{S}</math>, <math>\text{mS}</math>)</li> <li>• Total Dissolved Solids (ppm)</li> <li>• Temperature (<math>^{\circ}\text{C}</math>, <math>^{\circ}\text{F}</math>)</li> </ul>
Temperature Compensation	Automatic from 0 to $60^{\circ}\text{C}$ ( $32 - 140^{\circ}\text{F}$ ), with temperature compensation factor variable between 0 to 5 % per $^{\circ}\text{C}$
Probe Operating Temperature	0 to $60^{\circ}\text{C}$ ( $32$ to $140^{\circ}\text{F}$ )
Probe Dimension	Round, 22 mm diameter x 120 mm length
Probe Weight	approx. 65 g

Range	Measurement	Resolution	Accuracy
200 $\mu\text{S}$	0 to 200.0 $\mu\text{S} / \text{cm}$	0.1 $\mu\text{S} / \text{cm}$	± (2 % F.S. + 1 digit)
2 $\text{mS}$	0.2 to 2.000 $\text{mS} / \text{cm}$	0.001 $\text{mS} / \text{cm}$	
20 $\text{mS}$	2 to 20.00 $\text{mS} / \text{cm}$	0.01 $\text{mS} / \text{cm}$	
200 $\text{mS}$	20 to 200.0 $\text{mS} / \text{cm}$	0.1 $\text{mS} / \text{cm}$	

F.S. = Full Scale

### C. TDS (Total Dissolved Solids)

Range	Measurement	Resolution	Accuracy
200 ppm	0 to 132 ppm	0.1 ppm	± (2 % F.S. + 1 digit)
2,000 ppm	132 to 1,320 ppm	1 ppm	
20,000 ppm	1,320 to 13,200 ppm	10 ppm	
200,000 ppm	13,200 to 132,000 ppm	100 ppm	

F.S. = Full Scale

### D. Temperature

Function	Measurement	Resolution	Accuracy
°C	0°C to 60°C	0.1°C	± 0.8°C
°F	32°F to 140°F	0.1°F	± 1.5°F

### E. Dissolved oxygen

Oxygen Probe	Polarographic type oxygen probe		
Probe Compensation and Adjustment	Temperature	0 to 50°C, automatic, (3 to 122 °F)	
	Salt	0 to 39 % Salt	
	Height	0 to 8900 meter	
Probe Weight	approx. 195 g		
Probe Size	Round, 190 mm length x 28 mm diameter		

Measurement	Range	Resolution	Accuracy (23 ± 5°C)
Dissolved Oxygen	0 to 20.0 mg/L	0.1 mg/L O <sub>2</sub>	± 0.4 mg/L O <sub>2</sub>
Oxygen in Air	0 to 100 %	0.1 % O <sub>2</sub>	± 0.7 % O <sub>2</sub>

## 2. Front Panel Description (Fig. A)

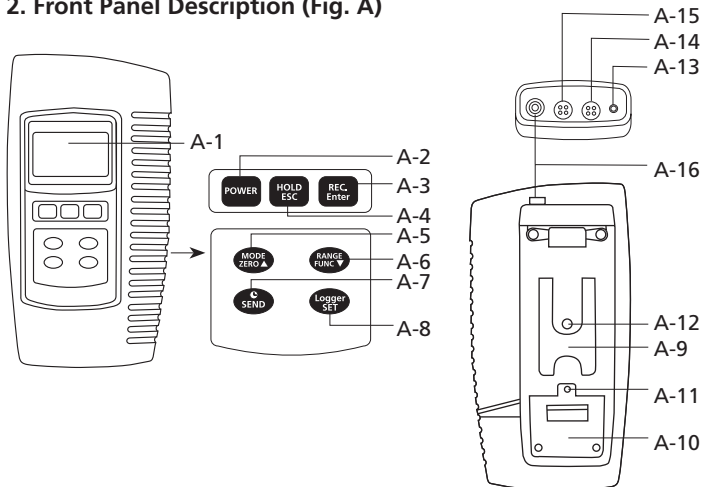

A-1 Display

A-2 Power Button

A-3 REC Button (Enter Button)

A-4 HOLD Button (ESC Button)

A-5 Mode Button (▲ Up Button, Zero Button)

A-6 Function Button (Range Button, ▼ Down Button)

A-7 Send Button (Clock Button)

A-8 SET Button (Logger Button)

A-9 Stand

A-10 Battery Compartment Cover

A-11 Battery Cover Screw

A-12 Tripod Fix Nut

A-13 Temp. Socket (pH ATC Socket)

A-14 CD Socket

A-15 DO Socket

A-16 pH Socket (BNC Socket)

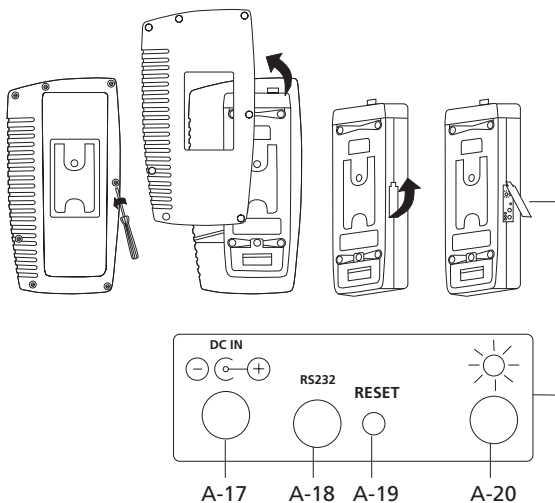

A-17 DC 9V Power Adapter Input Socket

A-18 RS-232 Output Terminal

A-19 System Reset Button

A-20 LCD Brightness Adjust

**Attention:**

Please do not put more than one electrode only into the water sample when using an instrument that works with various electrodes.

Only start the measurement for which the according electrode is immersed in the sample.



### 3. pH/mV Measuring and Calibration Procedure

**The meter default settings are as follows:**

- The display unit is set to pH.
- The temperature unit is set to °C.
- Manual temperature setting (without ATC probe connection)
- Auto power off.
- Data logger function sampling time: 2 seconds.

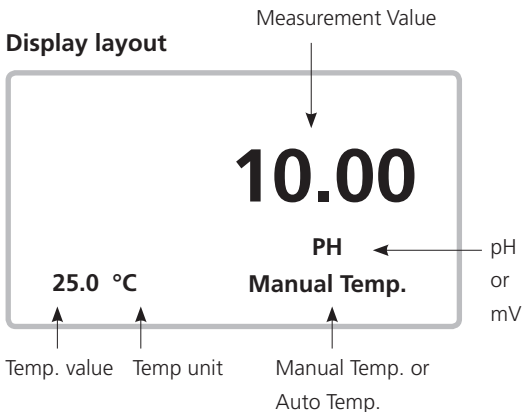

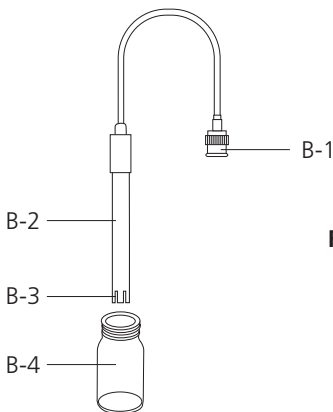

**Fig. B**

### **3.1 pH measurement (with manual temperature setting)**

- 1) Attach the pH Electrode by installing the "Probe Plug" (Fig. B-1) into the "pH Socket/BNC Socket" (Page 5, Fig. A-16).
- 2) Power on the meter by pressing the "Power" button once.
- 3) Keep pressing the "Mode" button until the display of bottom right shows "pH" and "Manual Temp." indicator.
- 4) **Adjust the Manual Temp. value exactly to the same temperature as the solution. For procedure refer to chapter 7.7, page 28.**
- 5) Remove cap and hold the pH Electrode body (Fig. B-2) and completely immerse the "Sensing Head" (Fig. B-3) in the solution to be measured and gently swirl the probe.
- 6) The upper display will show the pH value, the bottom left display will show the Manual Temp. setting.

### 3.2 pH measurement (with ATC , automatic Temperature Compensation)

- 1) All the procedures are the same as for 3.1 “pH measurement (manual temperature setting)”, except for attachment of a temperature probe by inserting the plug of the temperature probe into the “Temp. Socket” (Page 5, Fig. A-13), and immersing the sensing head of the temperature probe into the measurement solution.
- 2) The upper display will show the pH value, the bottom left display will show the Temp. value of the measured solution, and the bottom right display will show “Auto Temp.” as example below:

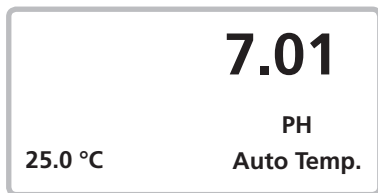

**When not in use the “Electrode Sensing Head” (Page 8, Fig. B-3) should always be immersed in water by part-filling the probe cap, (Page 8, Fig. B-4) and ensuring that the cap is firmly lifted onto the probe. Failure to do so will reduce probe life.**

### 3.3 mV Measurement

The instrument has a built in mV (millivolt) measurement function, which enables you to make ion-selective, ORP (oxidation reduction potential), and other precise mV measurements.

- 1) Attach the ORP Electrode by installing the “Probe Plug” of the ORP electrode into the “pH Socket/BNC Socket” (Page 5, Fig. A-16).
- 2) Power on the meter by pressing the “Power” button once.
- 3) Keep pressing the “Mode” button until the display at bottom right shows “PH” and “Manual Temp.” indicator.

**Press the “Function” button once so that the bottom right display shows “mV” .**

4) The upper display will show the mV value.

### **3.4 pH calibration**

#### **Calibration - Introduction**

An “ideal” pH Electrode generates 0 mV at pH 7.00 (177.4 mV at pH 4). The meter has been calibrated with signals which simulate the “ideal” pH Electrode (based on 25°C ambient environment). However not every pH Electrode is as accurate as the “ideal” one, so calibration procedures are necessary before first time measurement. In addition to calibration before first time measurement, users are also recommended to carry out regular calibration to ensure high accuracy measurements.

#### **Required Equipment for Calibration**

- 1) pH Electrode.
- 2) pH buffer solutions.

#### **Calibration Procedure**

- 1) Attach the pH Electrode by installing the “Probe Plug” (Page 8, Fig. B-1) into the “pH Socket/BNC Socket” (Page 5, Fig. A-16).
- 2) Power on the meter, set the mode to pH measurement, and the bottom right display will show “PH” .
- 3) Adjust the “Temperature Compensation Value” to make it the same temperature as the pH buffer solution.
  - **Manual temperature compensation value adjustment procedure, refer to 7-7, page 28.**
  - **Automatic temperature compensation, refer to 3.2, Page 9.**
- 4) Hold the “pH Electrode body” (Page 8, Fig. B-2) and completely immerse the “Sensing Head” (Page 8, Fig. B-3) in the buffer solution and gently swirl the probe. The display will show the pH value.

- 5) Press the "REC" button and "HOLD" button at the same time. The display will show the following screen as an example. Now release.

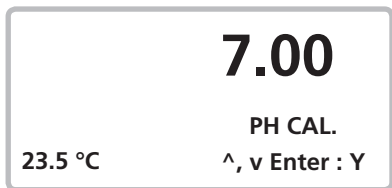

- 6) • If the buffer solution is pH 7.0 ( $\pm 1$  pH), the upper display will show 7.00 automatically.
  - If the buffer solution is pH 4.0 ( $\pm 1$  pH), the upper display will show 4.00 automatically.
  - If the buffer solution is pH 10.0 ( $\pm 1$  pH), the upper display will show 10.00 automatically.
  - If the buffer solution value is beyond pH 7.00, pH 4.00, pH 10.00 (for example 7.01, 4.02, 10.03) then use "▲" button, "▼" button to adjust the display value to exactly match the pH buffer solution value.
- 7) Press the "Enter" button twice to save the calibration data and finish the calibration procedure.
- 8) The described procedure can be performed for the following calibration points:

**pH7 calibration**

**pH4 calibration**

**pH10 calibration**

- Calibration should always start with pH7, followed by pH4 and / or pH10 calibration.
- Rinse the electrode with distilled water before each calibration point.

- Repeat the above calibration procedures at least twice to ensure accuracy.

### 3.5 ORP calibration

- 1) Attach the ORP electrode (optional, ORP-14) by connecting the ORP electrode to the meter.
- 2) Power on the meter, and set the mode and function to “mV” (refer to chapter 3.3, Page 9).
- 3) Immerse the sensing head of the ORP electrode in the ORP standard buffer solution. The upper display will show the ORP value in mV.
- 4) Press the “REC” button and “HOLD” button at the same time. The display will show the following screen as an example. Now release.



- 5) Use “▲” button, “▼” button to adjust the upper display value to exactly match the ORP buffer solution value. Press the “Enter” button twice to save the calibration data and finish the calibration procedure.
  - **ORP calibration is only possible if the ORP buffer solution value is > 100 mV.**
  - **ORP calibration at less than 100 mV is not permitted.**

## 4. Conductivity/TDS Measuring and Calibration Procedure

### The meter default settings are as follows:

- The display unit is set to conductivity ( $\mu\text{S}$ ,  $\text{mS}$ ).
- The temperature unit is set to  $^{\circ}\text{C}$ .
- Temp. compensation factor is set to 2.0% per  $^{\circ}\text{C}$ .
- Auto range.
- Auto power off.
- Data logger function sampling time:  
2 seconds.

### Display layout

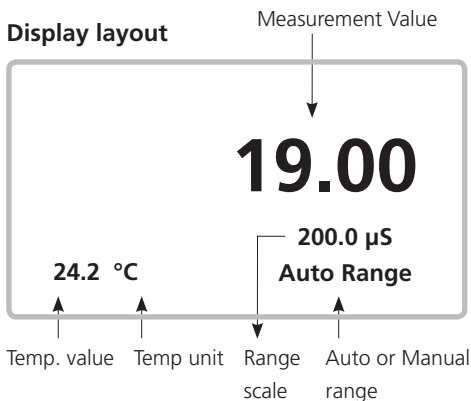

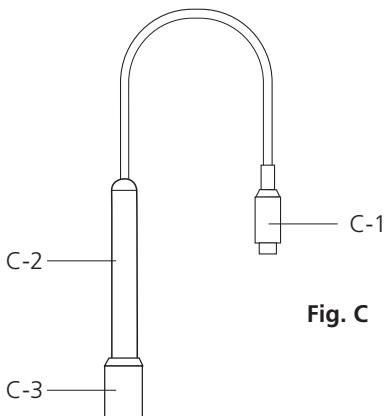

**Fig. C**



#### **4.1 $\mu\text{S}$ , $\text{mS}$ measurement**

- 1) Attach the Conductivity Probe by installing the "Probe Plug" (Fig. C-1) into the "CD Socket" (Page 5, Fig. A-14).
- 2) Power on the meter by pressing "Power" button once.
- 3) Keep pressing the "Mode" button until the bottom right display shows a value (e.g. "200  $\text{mS}$ ") and "Auto Range".
- 4) Remove probe cap and hold the probe body (Fig. C-2) and completely immerse the "Sensing Head" (Fig. C-3) in the solution to be measured. Swirl the probe to let any air bubble escape from the sensing head.
- 5) The display will show the conductivity values in either " $\text{mS} / \text{cm}$ " or " $\mu\text{S} / \text{cm}$ ". At the same time the bottom left display will show the Temp. value of the measured solution.



## Manual range operation

The meter default is set to auto range mode. Under auto range measurement, the bottom right display will show the "Auto Range" indicator. If manual range mode is required, the procedures are as follows:

- 1) Press the "Range" button continuously for at least two seconds until the bottom right display shows the "Manual Range" indicator. Release the "Range" button. Now the meter is set for manual range operation.
- 2) Press the "Range" button once to change the range. The range (200  $\mu$ S, 2 mS, 20 mS, 200 mS) will show under the measurement value.
- 3)
  - If the display shows "  ", it indicates an overrange. Select the next, higher range.
  - If the display shows "  ", it indicates an underrange. Select the next, lower range.
- 4) To change Manual Range back to Auto Range, press the "Range" button continuously for at least two seconds until the bottom right display shows the "Auto Range" Indicator. Release the "Range" button. Now the meter is set for Auto range mode again.

## Change the Temp. unit to °F

To change the Temp. unit from °C to °F, please refer to page 28, chapter 7.6 (Temp. Unit Default Setting)

## Change the Temp. Coefficient Factor

The default Temp. compensation factor value of the measurement solution is set to 2.0% per °C. To change it, please refer to page 28, chapter 7.8 (Temp. Compensation Factor Setting).

## 4.2 TDS (ppm) measurement

Measuring procedures are the same as above *4.1 Conductivity ( $\mu\text{S}$ ,  $\text{mS}$ ) measurement*, except for changing the display unit from  $\mu\text{S}$ ,  $\text{mS}$  to ppm. For detailed procedures please refer to page 29, chapter 7.9 CD ( $\mu\text{S}$ ,  $\text{mS}$ ), TDS (ppm) Setting.

## 4.3 Calibration

1) Obtain a the standard conductivity solution:

For example :

- 2 mS range calibration solution :

### **1.413 mS Conductivity Standard Solution**

- 200  $\mu\text{S}$  range calibration solution :

### **80 $\mu\text{S}$ Conductivity Standard Solution**

- 20 mS range calibration solution :

### **12.88 mS Conductivity Standard Solution**

or other Conductivity Standard Solution

2) Install the "Probe Plug" (Page 14 Fig. C-1 ) into the "CD Socket" (Page 5, Fig. A-14).

3) Power on the meter, and set the mode to conductivity measurement (  $\mu\text{S}$ ,  $\text{mS}$  ).

4) Hold the probe body (Page 14, Fig. C-2) and completely immerse "Sensing Head" ( Page 14, Fig. C-3 ) in the standard solution. Swirl the probe to let any air bubble escape from the sensing head. The display will show the conductivity  $\text{mS}$  (  $\text{mS}$  ) values.

5) Press the "REC" button and "HOLD" button at the same time. The display will show the following screen, as an example. Now release.

- 6) Use “▲” button (Page 5, Fig. A-5), “▼” button to adjust the upper display value to match the standard conductivity value.
- 7) Press the “Enter” button twice to save the calibration data, and finish the calibration procedure.
- **If only one calibration point is needed, just set the 2 mS range (1.413 mS Cal.).**
  - **A multi-point calibration procedure should always start with 2 mS range (1.413 mS Cal.), then proceed to other ranges (20  $\mu$ S range, 20 mS range or 200 mS range) if necessary.**



## 5. DO (Dissolved Oxygen) Measuring and Calibration Procedure

**ATTENTION:** Make sure the Oxygen probe is filled with Electrolyte!

To fill the Probe's Electrolyte, refer to chapter 5.3 "Probe maintenance", page 22.

**The meter default settings are as follows:**

- The display unit is set to % O<sub>2</sub>.
- The temperature unit is set to °C.
- Auto power off.
- Data logger sampling time: 2 seconds.

### Display layout

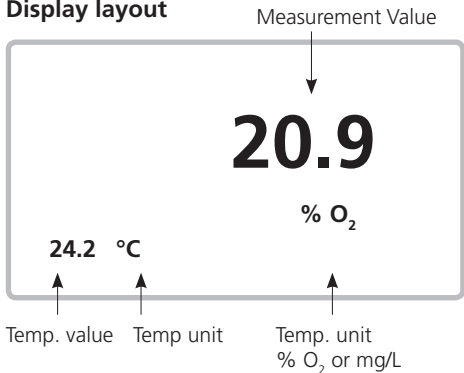

## 5.1 Dissolved Oxygen measurement

Fig. D

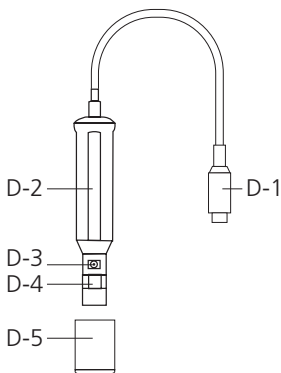

- 1) Attach the Oxygen Probe by installing the "Probe Plug" (Fig. D-1) into the "DO Socket" (Page 5, Fig. A-15).
- 2) Power on the meter by pressing the "Power" button once.
- 3) Keep pressing the "Mode" button until the bottom right display shows "%O<sub>2</sub>".

**CAUTION! Ensure calibration on air before measurement. Wait approx. 2 minute until the reading value stabilises. If the reading value on air is not within 20.7 to 21.1 (20.9 ± 0.2), then proceed with calibration procedures first. For calibration procedures, please refer chapter 5.2, page 21. After completing the calibration procedures, the display should show a value between 20.8 and 21.0 (20.9 ± 0.1).**

- 4) Press the "Function" button once, and the bottom right display will show "mg/L". Now the meter is ready for the Dissolved Oxygen measurement.

- 5)
  - Remove the protective cover from the probe head and immerse the probe to a depth of at least 10 cm in the measured liquid in order for the automatic temperature compensation to take effect.
  - Thermal equilibrium must occur between the probe & the measurement sample, which usually takes to a few minutes if the Temp. difference between the two is only a few degrees Celsius.
  - To measure the dissolved oxygen content in any given liquid, it is sufficient to immerse the tip of the probe in the solution, making sure that the velocity of the liquid coming into contact with the probe is at least 0.2 - 0.3 m/s. This is achieved by swirling the probe in the solution.
  - During laboratory measurements, the use of a magnetic stirrer/ agitator is recommended. In this way, errors due to air diffusion in the solution are reduced to a minimum.
- 6) The display will show the Dissolved Oxygen values (mg/L). At the same time, the bottom left display will show the Temp. value of the measured solution.
- 7) Rinse the probe carefully with normal tap water after each series of measurements.

### **Oxygen in the air**

When the display unit shows “%O<sub>2</sub>”, this represents an approximate air Oxygen value.

### **Changing the Temp. unit to °F**

To change the Temp. unit from °C to °F, please refer to page 28, chapter 7.6 (Temp. Unit Default Setting).

### **“% Salt” compensation value adjustment**

To change the % Salt compensation value, refer to page 29, chapter 7.10 (% Salt Compensation value Setting).

## “Height” (Altitude) compensation value adjustment

To change the Height compensation value, please refer to page 29, chapter 7.11 (Height Compensation value Setting).

### 5.2 Calibration

- 1) Install the “Probe Plug” (Page 19, Fig. D-1) into the “DO Socket” (Page 5, Fig. A-15).
- 2) Power on the meter by pressing the “Power” button once.
- 3) Keep pressing the “Mode” button until the bottom right display shows “%O<sub>2</sub>”.

**Wait for at least 5 minutes until the display reading values stabilise with no fluctuation.**

- 4) Press the “REC” button and “HOLD” button at the same time. The display will show the following screen, as an example. Now release.

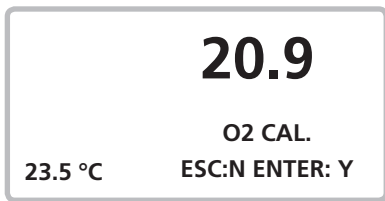

- 5) Press the “Enter” button twice. This will save the calibration data and finish the calibration procedure. Finally the lower display will show “O2 CAL. OK”. Return to the normal screen. The complete calibration procedure will take approximately 30 seconds.

**Calibration - additional information:**

**As oxygen in air is typically 20.9 %, use ambient air O<sub>2</sub> for quick & precise calibration.**

## 5.3 DO Probe maintenance

### a) First time use of the meter:

To keep the DO probe in the best condition, be sure to fill the Oxygen Probe, with Electrolyte prior to first use.

### b) After using the probe for a certain period:

If the user cannot calibrate the meter properly or the meter's readings are not stable, please check the oxygen probe to see if the electrolyte in the probe head container has run out or the diaphragm (inside the probe head) has a problem (e.g. is dirty). If yes, please fill the electrolyte or change the diaphragm set. Then re-calibrate.

### Diaphragm (probe head including diaphragm set):

A key component of the oxygen probe is the thin Teflon diaphragm housed in the tip of the probe. This diaphragm is permeable by oxygen molecules but not by the considerably larger molecules contained in the electrolyte. Accordingly oxygen may diffuse throughout the electrolyte solution contained in the probe, and its concentration may be quantified by the measurement circuit. This sensitive diaphragm is rather delicate and is easily damaged if it comes into contact with solid objects or is subjected to knocks. If the diaphragm is damaged or the electrolyte has run out, please see following procedure:



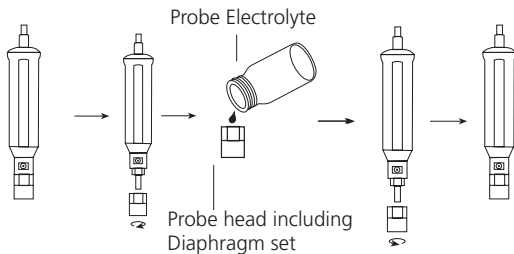

- 1) Unscrew the "Probe Head" (Page 23, Fig E-3).
- 2) Pour out the old Electrolyte from the container in the "Probe head".
- 3) Fill the container with new Electrolyte.
- 4) Screw the probe head (Fig E-3) back onto the probe body.
- 5) When not in use, insert the probe head into the probe protection cover (Page 19, Fig. D-5) that is equipped with a wet sponge.

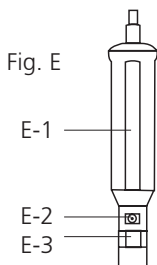

Fig. E

E-1 Probe body  
 E-2 Temp. sensor  
 E-3 Probe head

## **6. Data Load, Data Record, Data Logger**

### **6.1 Data Hold**

During the measurement, press the "Hold" button once to hold the measured value and the LCD will display a "HOLD" symbol. Press the "Hold" button once again to release the data hold function.

### **6.2 Data Record (MAX, MIN reading)**

- 1) The data record function records the maximum and minimum readings. Press the "REC" button once to start the Data Record function and a "REC" symbol will be displayed.
- 2) With the "REC" symbol on the display:
  - a) Press the "REC" button once more. The "REC MAX" symbol along with the maximum value will appear on the display. To delete the maximum value, just press the "Hold" button once. The display will then show only the "REC" symbol and the meter will continue to record data in the memory.
  - b) Press the "REC" button again. The "REC MIN" symbol along with the minimum value will appear on the display. To delete the minimum value, just press the "Hold" button once. The display will then show only the "REC" symbol and the meter will continue to record data in the memory.
  - c) To exit the memory record function, just press the "REC" button for at least 2 seconds. The display will revert to the current reading.

### **6.3 Data Logger**

The data logger function can save 16,000 readings with time and date. (Real time data logger with built-in-clock (hour-min-sec., year-month-date)).

The data logger procedure is as follows:

- a) Pushing the "Logger" button once will show the sampling time value on the bottom left display then disappeared.
- b) Press the "REC" button once to start the Data Record function and a "REC" symbol will be displayed.
- c) **Auto Data Logger**

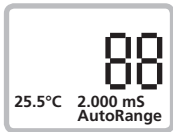

The Sampling frequency can be set from 1sec to 8h 59min 59sec (refer to chapter 7.4 page 27). E.g.: If a sampling frequency of 1 min is set, the meter stores the measured value every minute until the data logger function is stopped. Press the "Logger" button once to start the Auto Data Logger function, at the same the bottom right display will show the indicator "Recording....". Now the Data Logger function has started. The upper display will show a "DATA" indicator along with "REC" marker.

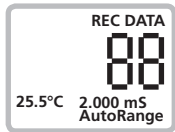

Press the "Logger" button once to stop the data logger function. The "DATA" indicator will disappear. If you press the Logger button once more the Data Logger function will re-start.

- d) **Manual Data Logger** (Sampling time is set to 0 second). Please refer to chapter 7.4 page 27. Press the "Logger" button once to save one set of data in the memory. At the same time the bottom right display will flash the indicator "Recording....". Now the Data logger function has started. The upper display will show the "DATA" indicator along with the "REC" marker.
- e) **Memory full**  
With the data logger in action, if the bottom right display shows "Full", it indicates the memory has over 16,000 sets and is therefore full.
  - To find out the Free Memory, please refer to chapter 7.1, Page 27.
  - To clear the memory of data, please refer to chapter 7.2, Page 27.

## 7. Advanced Adjustment Procedures

Before carrying out the following Advanced Adjustment Procedures exit the "Hold function" and the "Record function" first. The display will not show the "HOLD" and the "REC" marker.

- 1) Press the "SET" button for at least two seconds until the lower display shows:

XXXXX Memory Space

Push the "ESC" button to return to the normal measuring display.

- 2) To select "Advanced Setting Function", press and hold the SET button, then press again to successively show the following:

- 7.1 Memory Space
- 7.2 Clear Memory
- 7.3 Date/Time Set
- 7.4 Sample Time
- 7.5 Auto Power Off
- 7.6 Temp. Unit

The following functions appear only if the corresponding measurement function is selected (pH, CD, DO)

- 7.7 M. TEMP. SET (pH mode)
- 7.8 Temp. Comp. (CD mode)
- 7.9 CD, TDS Select (CD mode)
- 7.10 % Salt SET (DO Mode)
- 7.11 Height Value (DO Mode)
- 7.12 ESC-> Finish

- 3) To make advanced Adjustments, use the following buttons:  
"ESC", "Enter", "▲" Up, "▼" Down, "SET".

### 7.1 Check Memory Space

To check the free memory, press and hold the SET button for at least 2 seconds. The display will show.

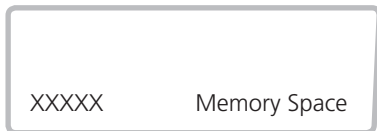

XXXXX is the free memory balance. For example XXXXX=15417.

### 7.2 Clear Memory

To delete readings from the memory:

- Push ENTER button twice to confirm.
- Press the ESC button once to quit, and return to the main measurement display.

### 7.3 Date/Time Setting

- Use "▲" Up, "▼" Down and "Enter" (->) to set the Date (year-month-date) and the Time (hour-min-sec).
- After Date/Time adjustment, push the "Enter" button, then press the "ESC" button to save the clock data into the memory, and return to the normal display.

### 7.4 Sample Time Setting

- Use "▲" Up, "▼" Down and "Enter" (->) to select the Sample Time (hour-min-sec).
- After Sample Time adjustment, push the "Enter" button, then press the "ESC" button to save the clock data into the memory and return to normal display.

## 7.5 Auto Power Off Default Setting

- Use “▲” Up, “▼” Down to select “1” or “0”.

1 = Auto power On.  
0 = Auto power Off.

- After Auto Power Off adjustment, push the “Enter” button, then press “ESC” to save the data and return to the normal display.

## 7.6 Temp. Unit Default Setting

- Use “▲” Up, “▼” Down to select “1” or “0”.

1 = °F  
0 = °C

- After adjusting the Temperature unit, push the “Enter” button, then press “ESC” to save the data and return to the normal display.

## 7.7 pH Manual Temp. Setting

- This procedure is only to adjust the manual temperature compensation value for pH measurement.
- The lower display will show:

M. TEMP. SET  
^, v Enter:Y

- Use “▲” Up, “▼” Down to select the desired manual Temp. compensation value.
- Press “Enter” once, then press “ESC” to save the data and return to the normal display.

## 7.8 Temp. Compensation Factor Setting

- This procedure is only used for the Conductivity function.
- Use “▲” Up, “▼” Down to select the Temp. Compensation Factor (% per °C) of the measured solution.

- After setting the desired value, press "Enter", then press "ESC" to save the data and return to the normal display.
- Temp. Compensation Factor is typically set to 2.0% per C degree.

### 7.9 CD ( $\mu\text{S}$ , mS), TDS (ppm) Default Setting

- This procedure is only used for the Conductivity function.
- Use " $\blacktriangle$ " Up, " $\blacktriangledown$ " Down to select "1" or "0".

0 =  $\mu\text{S}$ , mS  
1 = ppm

- After adjusting the unit ( $\mu\text{S}/\text{mS}$ , ppm), press "Enter", then press "ESC" to save the data and return to the normal display.

### 7.10 DO % Salt Compensation Value Setting

- This procedure is only available for the DO function.
- The lower display will show:

% Salt SET  
^,v Enter:Y

- Use " $\blacktriangle$ " Up", " $\blacktriangledown$ " Down to select the desired % Salt Compensation Value .
- Press "Enter" once, then press "ESC" to save the data and return to the normal display.
- % Salt is typically set to 0 %.

## 7.11 DO Height (Altitude) Compensation Value Setting

- This procedure is only for the DO function.
- The lower display will show:

0 = meter  
1 = ft (foot)

FT= foot    1 Foot = 0.3048 m

- Use "▲" Up, "▼" Down to select "0" or "1".
- Press "Enter" once, and the lower display will show:

Height Value  
Meter

- Use "▲" Up, "▼" Down to select the desired Height value.
- Press "Enter" once, then press "ESC" to save the data and return to the normal display.
- Typical setting is 0 meter (0 feet).

## 7.12 Escape from the SETTING function

Press "ESC" once to quit and return to the normal measurement display or press "Enter"!



## 8. Data Output From The Meter

To send data out from the meter, exit the "Hold function" and the "Record function" first. The display will not show "HOLD" and "REC" markers.

- 1) Press and hold the "SEND" button for at least 2 seconds until the bottom right display shows "Transmit mode", then release the button.

The display will show the following screen alternately:

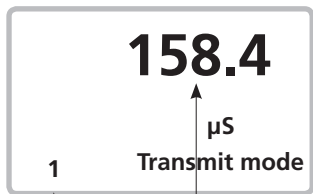

Block no.

First data in  
each block

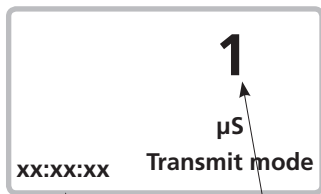

Start time of  
each block

Start data address  
of each block

Use "▲" Up, "▼" Down to select different data memory blocks (1 to 250).

**The meter can save up to a maximum of 16,000 data sets. These data will be saved into a maximum of 250 memory blocks.**

One "Memory Block" means: The data that can be saved in one routine Data Logger procedure. Please refer Chapter 6.3, Page 24.

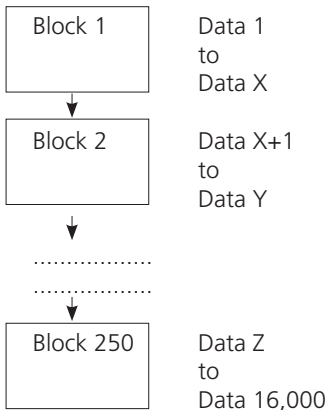

- 3) Once the desired Memory Block no. has been selected, push the "Send" button once, and the data in the Memory Block will transmit. During data output, the bottom right display will show "Sending Data!". When data output is completed, the bottom right display will show "Transmit mode" again.
- 4) Push "ESC" button to exit the data output function and return to the normal display.

### Remarks :

- **To transmit the data to a computer, connect an RS232 cable or USB cable, and start the Data Logger software.**
- **When transmitting data, each transmission sends only one Memory Block at a time. For example block 1, block 2 ... or block 250.**

## 9. RS232 PC-Serial Interface

The instrument has an RS232 PC serial interface via the RS-232 Out Terminal" (Page 6, Fig. A-18) .

Data output is via a 16 digit stream which can be downloaded to user's specific application. An RS232 lead with the following connection will be required to link the instrument to the PC serial port:

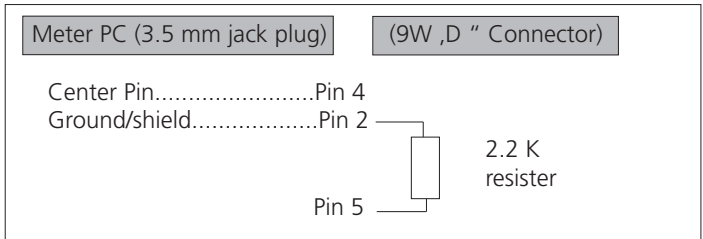

The 16 digit data stream will be displayed in the following format :

D15 D14 D13 D12 D11 D10 D9 D8 D7 D6 D5 D4 D3 D2 D1 D0

Each digit indicates the following status:

D15	Start Word = 02		
D14	4		
D13	Sending upper display data = 1 Sending lower display data = 2		
D12, D11	Annunciator for Display		
	$\mu\text{S} = 13$	mS = 14	ppm = 19
	pH = 05	mV = 18	
	mg/L = 07	% O <sub>2</sub> = 06	
D10	Polarity 0 = Positive 1 = Negative		
D9	Decimal Point (DP) position from right to left 0 = No DP, 1 = 1 DP, 2 = 2 DP, 3 = 3 DP		
D8 to D1	Display reading, D1 = LSD, D8 = MSD For example: If the display reading is 1234, then D8 to D1 is: 00001234		
D0	End Word = 0D		

### RS232 setting

Baud rate	9600
Parity	No parity
Data bit no.	8 Data bits
Stop bit	1 Stop bit

## 10. Battery Replacement

- 1) When the left corner of the display shows “”, it is necessary to replace the batteries (4x mignon size type AA 1.5V).
- 2) Unscrew the single retaining screw, and then slide open the “Battery Cover” (Page 5, Fig. A-10) and remove the batteries.
- 3) Replace with new batteries and slide on the cover. Replace the retaining screw.
- 4) Make sure the battery cover is tightly secured after changing the batteries.

## 11. System Reset

If the meter experiences problems, such as:

*CPU system is garbled (for example, the key button cannot be operated.....).*

Then system RESET will fix the problem. The system RESET procedure is as follows:

Use a pin tool to push the “System Reset Button” (Page 6, Fig. A-19). Then press “Power” on again to fix the problem.

## 12. ACCESSORIES

### Accessories for pH/Redox

Spare electrode for pH, pH 0 – 14, plastic/gel type, BNC-plug  
Redox electrode, plastic/gel, BNC-plug

### Accessories for pH- and Redox electrodes

pH-Buffer solution set pH 4, pH 7, pH 10 (25°C) colour coded 90 ml each in plastic bottles, traceable to N.I.S.T

pH Buffer solution 4.00 (25°C) red, 90 ml , traceable to N.I.S.T

pH Buffer solution 7.00 (25°C) yellow, 90 ml, traceable to N.I.S.T

pH Buffer solution 10.00 (25°C) blue, 90 ml, traceable to N.I.S.T

pH Buffer solution 4.00 (25°C) red, 1 ltr., traceable to N.I.S.T

pH Buffer solution 7.00 (25°C) yellow, 1 ltr., traceable to N.I.S.T

pH Buffer solution 10.00 (25°C) blue, 1 ltr., traceable to N.I.S.T

### Accessories for conductivity

Conductivity probe

Calibration solution 1413  $\mu\text{S}/\text{cm}$ , 500 ml, traceable to N.I.S.T

### Accessories for oxygen

Oxygen sensor

Spare membrane for oxygen sensor

Spare electrolyte for oxygen sensor

### Accessories

Temperature probe PT1000

RS232 cable

USB cable

Data logger software

Data acquisition software

Power supply

Case incl. foam for SensoDirect 150



### **Tintometer GmbH**

Lovibond® Water Testing  
Schleefstraße 8-12  
44287 Dortmund  
Tel.: +49 (0)231/94510-0  
Fax: +49 (0)231/94510-20  
verkauf@tintometer.de  
www.lovibond.com

Deutschland

### **Tintometer AG**

Hauptstraße 2  
5212 Hausen AG  
Tel.: +41 (0)56/4422829  
Fax: +41 (0)56/4424121  
info@tintometer.ch  
www.tintometer.ch

Schweiz

### **The Tintometer Limited**

Lovibond House / Solar Way  
Solstice Park / Amesbury, SP4 7SZ  
Tel.: +44 (0) 1980 664800  
Fax: +44 (0) 1980 625412  
water.sales@tintometer.com  
www.lovibond.com

UK

### **Tintometer South East Asia**

Unit B-3-12, BBT One Boulevard,  
Lebu Nilam 2, Bandar Bukit Tinggi,  
Klang, 41200, Selangor D.E  
Tel.: +60 (0)3 3325 2285/6  
Fax: +60 (0)3 3325 2287  
lovibond.asia@tintometer.com  
www.lovibond.com  
Malaysia



Technical changes without notice  
Printed in Germany 12/11  
Lovibond® and Tintometer®  
are Trademarks of the  
Tintometer Group of Companies